



inspired by  
bathroom lighting

ISSUE 10

**TLW**  
EST. 1996

NEW

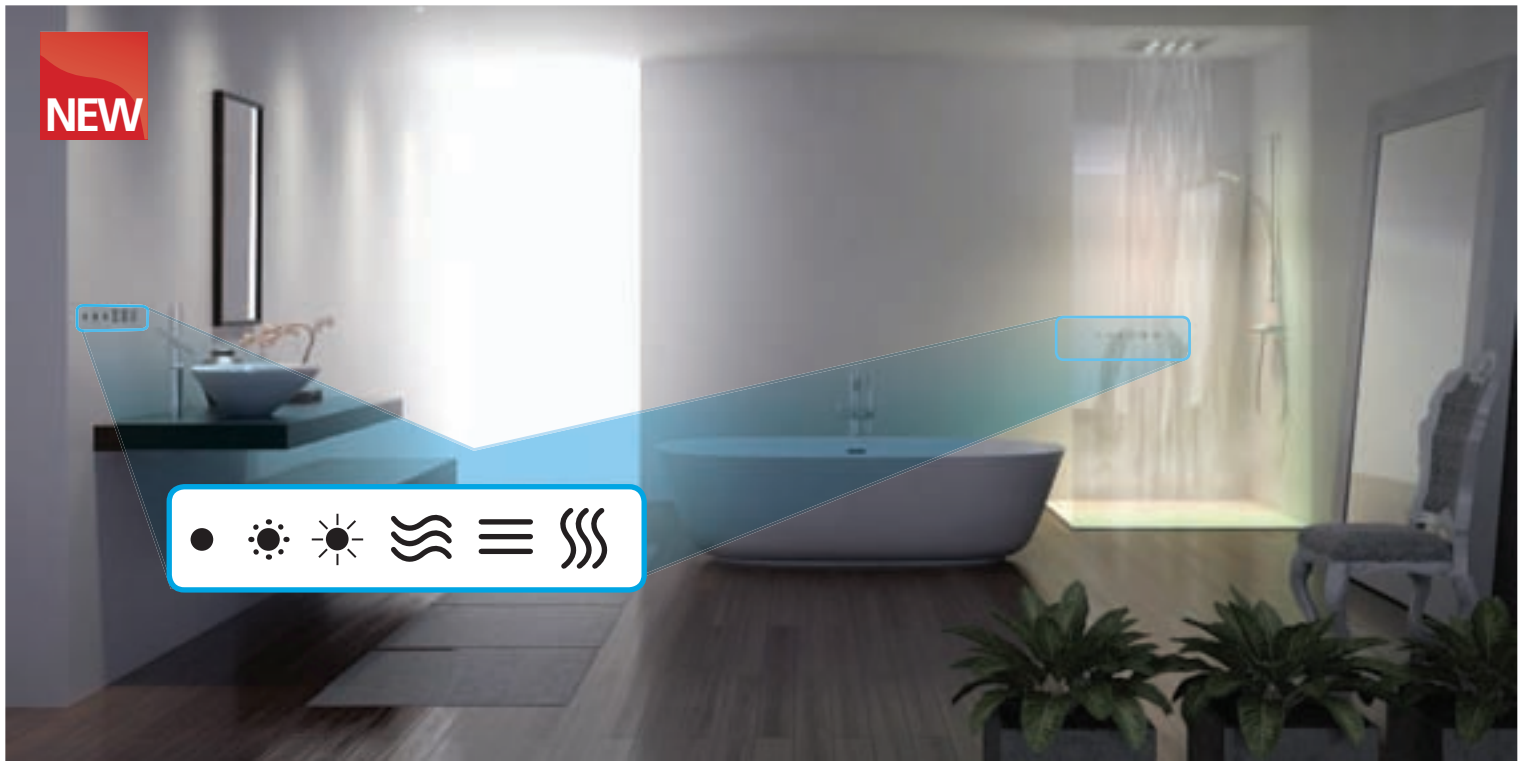

# taptile

## BATHROOM

## Discover Taptile

- The touch-sensitive Taptile can be used to control 2 individually dimmable lighting circuits - saving energy, providing a better bathroom ambience - and 'ditching the switch' - or pull cord.
- Taptile via its third non dimmable circuit can also be used to activate bathroom appliances such as extractor fans - ensuring they are only used when necessary and not whenever the lighting is switched on.
- Taptile is a simple ultra-slim panel that can be fitted behind any tiled, ceramic, wooden or drywall area.
- Taptile panels couldn't be simpler to install.
- No complicated wiring is required - Taptile systems are wireless.
- Taptile is 100% waterproof - each panel is completely sealed and can be fitted in wet areas.

See products on page 41



# inspired by bathroom lighting



Look out for our Energy Saving logo





## K05 – 3605\*

5 Light IP68 Pre-wired LED Kit

\*Colour of LEDs: White (WH) or Blue (BL)

- Easy to install kit
- 3 metres of cable per light
- IP44 Driver
- Non-replaceable LEDs

Cut Out  
  
 24mm

CE  IP68  ZONE 0

Diameter 30mm  
 Recess Depth 25mm



## K05 – 3610\*

10 Light IP68 Pre-wired LED Kit

\*Colour of LEDs: White (WH) or Blue (BL)

- Easy to install kit
- 3 metres of cable per light
- IP44 Driver
- Non-replaceable LEDs

Cut Out  
  
 24mm

CE  IP68  ZONE 0

Diameter 30mm  
 Recess Depth 25mm



### K05 – 3615\*

IP44 10-Marker Kit

\*Colour of LEDs: White (WH) or Blue (BL)

- Polished Stainless Steel
- 5mtr of cable per light
- IP44 Rated
- Energy saving



Diameter 30mm  
Recess Depth 30mm



### K05 – 3514\*

IP67 6-Light Mini Led Kit

\*Colour of LEDs: White (WH) or Blue (BL)

- IP67 Rated
- Plug and driver needs to be situated indoors unless housed in a waterproof enclosure



Diameter 15mm  
Recess Depth 27mm



### K05 – 3600\*

IP65 5-Light Square LED Kit

### K05 – 3601\*

Additional Square LED Light

\*Colour of LEDs: White (WH) or Blue (BL)

- IP65 Rated
- Easy to install kit
- 4mtrs of cable per light
- Up to 10 lights per kit
- IP44 Rated Driver



Size 40x40mm  
Recess Depth 50mm



K05-3601



Recess Depth 32mm

### K02 - 2105\*

IP65 Mini LED Spotlight

\*Colour of LEDs: Cool White (CW), Warm White (WW), Red (RD), Amber (AM), Green (GR)



Recess Depth 32mm

### K02 - 2110\*

IP65 Mini LED Spotlight Threaded Body with Nut

\*Colour of LEDs: Cool White (CW), Blue (BL)



- Finish: Aluminium
- IP65, 1 Watt
- 110° beam angle
- Plug and play



### K02 - 2115\*

IP65 Mini LED Spotlight Surface Mounted

\*Colour of LEDs:

Cool White (CW), Warm White (WW),

Diameter 60mm  
Depth 20mm



### K11 - 9215

1 Mtr Mini LED Extension

- Suitable for use with plug and play mini LED spotlights



### K11 - 9216

Plug and Play LED Driver

- Suitable for use with plug and play mini LED spotlights



**K05-3518\***  
IP68 Marker Light

**K05 – 3519\***  
5 Light IP68 Marker Light Kit

\*Colour of LEDs: White (WH), Blue (BL), Red (RD), Amber (AM) & Green (GR)

- Submersible up to 9 metres
- IP68 connector included
- Driver included
- 100m cable included

CE IP68 LED ENERGY SAVING ZONE 0

Diameter 40mm  
Recess Depth 36mm



K05-3518



**K02 – 2200\***  
IP65 Round Marker Lights

Diameter 49mm  
Recess Depth 50mm

\*Finish: Polished Brass (PB), Polished Chrome (PC), White (WH)

- 0.4 watts per light
- IP65 Rated
- Long life LEDs
- Cool to touch
- Non Dimmable
- Not suitable for mounting in walls
- 1 mtr of cable per light
- Needs LED driver K11-9016 (see page 39)

CE IP65 LED ENERGY SAVING



**K02 – 2230\***  
IP65 Square Marker Lights

Size 40x40mm  
Recess Depth 50mm

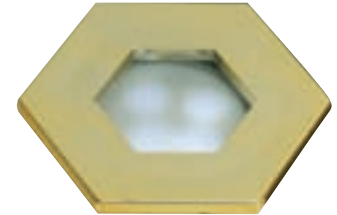

**K02 – 2260\***  
IP65 Hexagonal Marker Lights

Diameter 42mm  
Recess Depth 50mm



**K05-3511\***  
IP68 8-Point Marker Light

**K05 – 3512\***  
5 Light IP68 Marker Light Kit

\*Colour of LEDs: White (WH), Blue (BL), Red (RD), Amber (AM) & Green (GR)

- Submersible up to 9 metres
- IP68 connector included
- Driver included
- 100m cable included

CE IP68 LED ENERGY SAVING ZONE 0

Diameter 31mm  
Recess Depth 21mm



K05-3511



**K02-1220**  
IP54 LED Aluminium Cabinet Light  
■ LxWxD 375x23x6mm

**K02-1222**  
IP54 LED Aluminium Cabinet Light  
■ LxWxD 600x23x6mm

- Energy saving
- 5 x 1w LEDs
- 1.5mtr of cable
- Needs LED CC Driver K11-9017(See page 39)
- Non dimmable

CE IP54 LED ENERGY SAVING ZONE 2



NEW

**K02-1221**  
IP54 LED Aluminium Adjustable Cabinet Light  
■ LxWxD 375x23x25mm

**K02-1223**  
IP54 LED Aluminium Adjustable Cabinet Light  
■ LxWxD 600x23x25mm



**NEW**



### K30-2002\*

IP65 12V Tape LED

\*Colour of LEDs: White (WH), Warm White (WW), Blue (BL), Red (RD)

- 4.8W per metre
- 60 LEDs per metre
- Cutable every 50mm
- Roll length 6mtr
- Maximum recommended length - 6mtr
- 2mtr power lead with AMP plug
- Priced per metre
- Needs LED driver K11-8263, K11-8269 or K11-8270 (see page 39)
- Cut and seal service available



Length 1000mm  
Width 8mm



**NEW**

## Colour Changing LEDs



### K30-2005

IP65 12V Tape LED RGB 10mm

- 7.2w per metre
- 30 LEDs per metre
- Cutable every 50mm
- Maximum recommended length - 6mtr
- Priced per metre
- Needs LED driver K11-1307 or K11-9209 (see page 39)
- Needs remote controller K30-2011 (see page 39)
- Cut and seal service available



Length 1000mm  
Width 10mm

## Colour Changing LEDs



**NEW**



### K30-2004

IP68 LED RGB 5 Meter Kit

- IP68 Rated
- C/W Fixing kit Driver receiver & Remote control



Length 5000mm  
Width 12mm

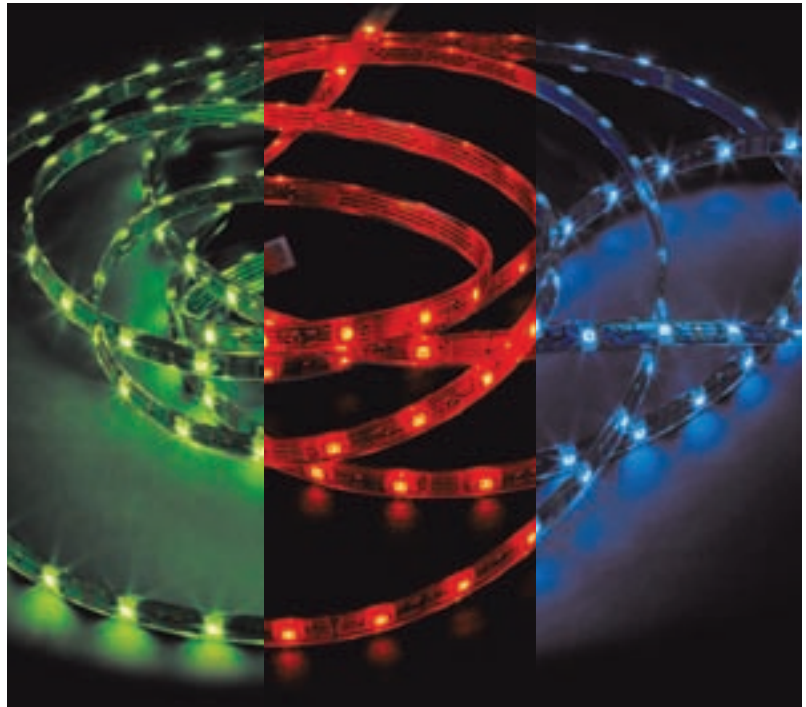

## Colour Changing LEDs



**K02-2402**  
Tri-Star Master

**K02-2403**  
Tri-Star Slave

- GU10 Size
- 5W CREE Lamp
- NO UV OR IR
- 35000hrs plus
- Mains voltage



**K02-2404**  
Tri-Star Remote



**K02-2405**  
Tri-Star GU10 RGB

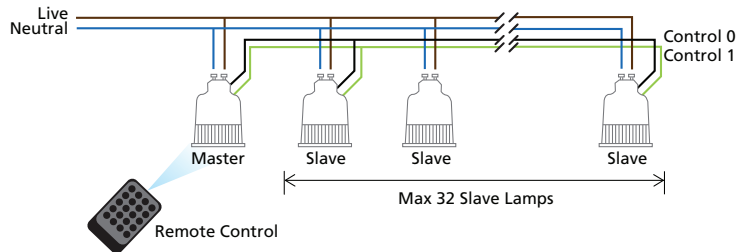

## Colour Changing LEDs



**D00-0100**  
RGB LED Shower Head

- Colour changing between red to green to blue automatically

**D00-0101**  
RGB LED Shower Head  
Temperature Sensitive

- Colour changing dependant on water temperature  
Green - cold Blue to Purple - warm Red - Hot

- LED's illuminate the water from the shower head
- Water pressure powered (no batteries needed)
- Minimum water pressure of 1.5 Bar required (max 5 Bar)
- Fits standard shower hose



Diameter 45mm  
Recess Depth 110mm





20w Lamp  
not included



### K05-3420SN

IP65 MR8 Walkover Light Satin Nickel

- Comes complete with mounting pot
- Fitted with 500mm of rubber cable
- Uses low voltage halogen or low voltage LED
- Needs low voltage transformer or LV LED driver
- Cut out with mounting pot is 40mm

- please enquire or see the transformers/drivers and lamp sections



Diameter 45mm  
Recess Depth 93mm

35w Lamp  
not included



### K05-3440SN

IP65 MR11 Walkover Light Satin Nickel

- Comes complete with mounting pot
- Fitted with 500mm of rubber cable
- Uses low voltage halogen or low voltage LED
- Needs low voltage transformer or LV LED driver
- Cut out with mounting pot is 54mm

- please enquire or see the transformers/drivers and lamp sections



Diameter 63mm  
Recess Depth 110mm

50w Lamp  
not included



### K05-3460SN

IP65 MR16 Walkover Light Satin Nickel

- Comes complete with mounting pot
- Fitted with 500mm of rubber cable
- Uses low voltage halogen or low voltage LED
- Needs low voltage transformer or LV LED driver
- Cut out with mounting pot is 72mm

- please enquire or see the transformers/drivers and lamp sections



Diameter 79mm  
Recess Depth 140mm



### K05-3461

IP67 Round Walkover Light

- Mains or Low voltage
- Twin cable glands
- Includes mounting pot
- Needs Lamp and/or transformer/driver

- please enquire or see the transformers/drivers and lamp sections



Diameter 100mm  
Recess Depth 185mm



## D03-1410\*

IP44 Recessed Cabinet Light

\*Finish: N.Matt (NM), Polished Chrome (PC)

- IP44 rated
- 20w max
- Needs transformer R20-1610 (see page 39)

Diameter 76mm  
Recess Depth 23mm

Cut Out



62mm



## A12-6150\*

IP65 Low Voltage MR11

\*Finish: White (WH), Satin Nickel (SN), Polished Chrome (PC), Polished Brass (PB)

- IP65 Low Voltage MR11
- Needs LV transformer R20-1600 or R20-1600B on page 38
- Needs lamps G04-2011 or G04-3511 on page 45
- LED version available - use LED driver K11-9016 on page 39 and LED lamp K14-8312\* on page 43

Diameter 72mm  
Recess Depth 125mm

Cut Out



55mm



Fixed and tilt available - call or visit our website



**A12-6160\***

IP65 Low Voltage MR11 35mm Downlight Fire Rated

\*Finish: White (WH), Satin Nickel (SN), Polished Chrome (PC), Polished Brass (PB)

- IP65 Low Voltage MR11
- Needs LV transformer R20-1600 or R20-1600B on page 38
- LED version available - use LED driver K11-9016 on page 39 and LED lamp K14-8312\* on page 43



CE IP65 ZONE 1

Diameter 72mm  
Recess Depth 115mm



**A02-1101\***

IP54 LED 3x3watt Fixed Downlight

**A02-1102\***

IP54 LED 3x3watt Dimmable Fixed Downlight

\*Colour of Finish & LEDs: White & Cool White (WHCW), White & Warm White (WHWW), P.Chrome & Cool White (PCCW), P.Chrome & Warm White (PCWW), Silver & Cool White (SLCW), Silver & Warm White (SLWW)

- Energy saving
- 40 lm/w
- 30° beam angle
- Instant start
- Average life 30000hrs



CE IP54 ENERGY SAVING ZONE 1

Diameter 77mm  
Recess Depth 101mm



**K05-6000\***

7.9w IP65 LED Fire-Rated Downlighter



**K05-6002\***

7.9w IP65 LED Fire-Rated Dimmable Downlighter

\*Colour of Finish & LEDs: White & Cool White (WHCW), White & Warm White (WHWW), P.Chrome & Cool White (PCCW), P.Chrome & Warm White (PCWW), Silver & Cool White (SLCW), Silver & Warm White (SLWW)

- Brighter than a 50w mains halogen
- Zero Maintenance
- Life expectancy over 75000hrs
- Straight to mains wiring
- Complete with power converter
- Flexible cut out size
- 54lumens per watt
- IP65 rated
- Emergency available
- 34° Beam angle
- Retro-fit disc for larger holes



CE IP65 ENERGY SAVING ZONE 1

Diameter 90mm  
Recess Depth 84mm

# iCage Fire-Rated Downlights



Terminals comfortably accept 2 x 1.5 Twin and Earth cables with screwless snap-fit cover and cable clamp, for ease and speed of installation.

Patented intumescent disc.

Open design of fitting allows lamp to 'breathe' providing optimum lamp life and allows for use of ALL suitable branded lamps.

Sleeved AND double insulated high temperature cable.

Sprung clips for sturdy fixing in variable ceiling thicknesses providing light and lasting positioning to ceiling.

Supplied c/w GU10 & LV Lampholders (Except low energy versions).

Moisture seal.

Ultra slim bevel provides minimalistic look.

Twistlock operation for easy lamp installation and replacement.



**A20-3617\***  
Fixed GU10/LV

Diameter 90mm  
Recess Depth 137mm



**A12-6258\***  
IP65 GU10/LV

Diameter 108mm  
Recess Depth 147mm



**A20-3618\***  
Fixed GU10 CFL/LED

Diameter 90mm  
Recess Depth 145mm



**A20-3619\***  
Tilt GU10/LV

Diameter 95mm  
Recess Depth 131mm



**A12-6259\***  
IP65 GU10 CFL/LED

Diameter 108mm  
Recess Depth 151mm



\*Finish: White (WH), Satin Nickel (SN), Polished Chrome(PC), Polished Brass (PB)

- Can be covered in Insulation - Glass or Rock Wool only
- Aluminium backed lamps NOT required
- Supplied with GU10 & LV lamp holders (Not A20-3618\* & A12-6259\*)
- Extra large terminals for fast loop in loop out wiring
- Will accept some GU10 CFL and LED lamps
- Tested to Building Regulations Parts B, C, E and L

- Open cage fitting allows for lamp to breathe and not over heat
  - GU10 CFL/LED fittings have a spring-loaded GU10 lamp holder for ease of lamp change
  - Needs lamp and or transformer/driver
- please enquire or see transformer/driver and lamp sections**

Fixed and tilt available - call or visit our website



**NEW**

**A12-6020\***

IP65 Mains Energy Saving Part L1 Fixed Downlight

\*Finish: White (WH), Satin Nickel (SN), Polished Chrome (PC)

Cut Out



85mm

Diameter 95mm  
Recess Depth 115mm



**A12-6025\***

IP65 Mains Energy Saving Part L1 Fixed Fire-Rated Downlight

\*Finish: White (WH), Satin Nickel (SN), Polished Chrome (PC)

- IP65 Mains shower light
- Part L1 compliant
- Needs Energy Saving lamp F50-6009 or F50-6011 (see page 42)

Cut Out



85mm

Diameter 100mm  
Recess Depth 130mm

CE IP65 ENERGY SAVING ZONE 1



**NEW**

Fixed only available - call or visit our website



**A12-6272\***

IP65 Mains Low Energy Showerlight Contractor Fire-Rated

\*Finish: Polished Chrome (PC), Satin Nickel (SN), White (WH)

- IP65 rated
- Full 90min Fire-rated
- Lamp not included
- Dedicated lamp holder for 75mm long GU10
- Will not accept a Halogen GU10
- Integrated Fire and Acoustic barrier
- Part 'C' compliant
- Part 'E' compliant
- Die-cast fitting

Cut Out



72mm

Diameter 86mm  
Recess Depth 135mm

CE IP65 ENERGY SAVING ZONE 1



Required Lamps on pages 42 and 44.

## Fire-Rated



### A12-6273\*

IP65 LV Contractor Downlight

\*Finish: White (WH), Polished Chrome (PC), Satin Nickel (SN)

- IP65 rated
- Full 90min Fire-rated
- Aluminium Lamp recommended
- Transformer needed
- Integrated Fire and Acoustic barrier

CE IP65 SOW MAX ZONE 1

- Part 'C' compliant, Part 'E' compliant
- Die-cast fitting
- Needs transformer/driver and lamp
- please enquire or see transformer/driver and lamp sections

Diameter 86mm  
Recess Depth 123mm



72mm

Fixed and tilt available - call or visit our website

Diameter 86mm  
Recess Depth 145mm

### A12-6260\*

IP65 LV Die-Cast Showerlight

\*Finish: White (WH), Satin Nickel (SN), Polished Chrome (PC), Polished Brass (PB)

- IP65 Die cast Low Voltage shower light
- Low voltage version need transformer R20-1600 or R20-1600B on page 38
- Comes complete with lamp

CE IP65 LAMP INCLUDED SOW MAX ZONE 1

### A12-6261\*

IP65 Die-Cast Mains Showerlight

### A10-6310\*

LV / Mains IP44 Shower light

\*Finish: White (WH), Polished Chrome (PC), Nickel Matt (NM), Polished Brass (PB)

- Needs transformer/driver and lamp
- please enquire or see transformer/driver and lamp sections

CE IP44 SOW MAX ZONE 2

Diameter 90mm  
Recess Depth 100mm



78mm

## Fire-Rated



### A12-6270\*

IP65 LV Pressed Showerlight

\*Finish: White (WH), Satin Nickel (SN), Polished Chrome (PC), Polished Brass (PB)

- IP65 Die cast Low Voltage shower light
- Low voltage version need transformer R20-1600 or R20-1600B on page 38
- Comes complete with lamp

CE IP65 LAMP INCLUDED SOW MAX ZONE 1

Diameter 115mm  
Recess Depth 82mm



65mm

### A12-6271\*

IP65 Mains Pressed Showerlight



### A12-6210\*

LV IP65 Die Cast Square Showerlight

\*Finish: White (WH), Satin Nickel (SN), Polished Chrome (PC), Polished Brass (PB)

- IP65 Shower Light
- Low Voltage
- Needs transformer R20-1600 or R20-1600B on page 38
- Comes complete with lamp

CE IP65 LAMP INCLUDED SOW MAX ZONE 1

Size 86x86mm  
Recess Depth 125mm

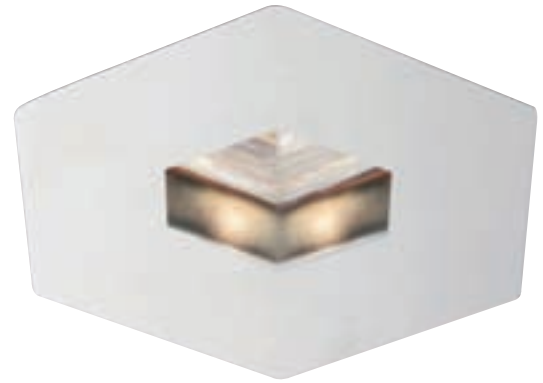

### A12-6220\*

LV IP65 Die Cast Hexagonal Showerlight

\*Finish: White (WH), Satin Nickel (SN), Polished Chrome (PC), Polished Brass (PB)

- IP65 Shower Light
- Low Voltage
- Needs transformer R20-1600 or R20-1600B on page 38
- Comes complete with lamp

CE IP65 LAMP INCLUDED SOW MAX ZONE 1

Size 88mm  
Recess Depth 125mm

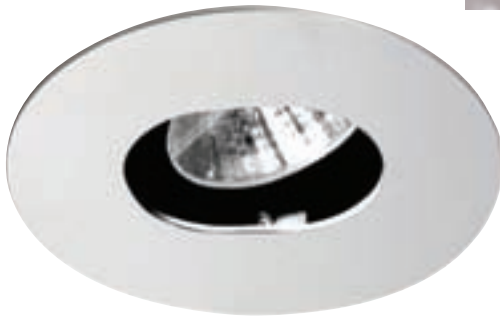

### A12-6230\*

LV IP65 Die Cast Round Tilt Showerlight

\*Finish: White (WH), Satin Nickel (SN), Polished Chrome (PC), Polished Brass (PB)

- IP65 Shower Light
- Low Voltage
- Needs transformer R20-1600 or R20-1600B on page 38
- Needs LV lamp - see page 45

CE IP65 LAMP INCLUDED SOW MAX ZONE 1

Diameter 86mm  
Recess Depth 130mm

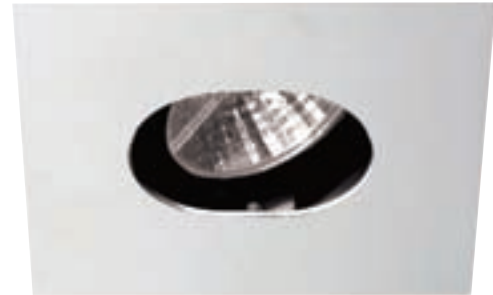

### A12-6240\*

LV IP65 Die Cast Square Tilt Showerlight

\*Finish: White (WH), Satin Nickel (SN), Polished Chrome (PC), Polished Brass (PB)

- IP65 Shower Light
- Low Voltage
- Needs transformer R20-1600 or R20-1600B on page 38
- Needs LV lamp - see page 45

CE IP65 LAMP INCLUDED SOW MAX ZONE 1

Size 86x86mm  
Recess Depth 130mm





### A12-6250\*

LV / Mains IP65 Showerlight

\*Finish: White (WH), Polished Brass (PB), Polished Chrome (PC), Nickel Matt (NM)

- IP65 Shower Light
- Low Voltage/mains
- Needs transformer/driver and lamp

- please enquire or see transformer/driver and lamp sections

CE IP65

Diameter 85mm  
Recess Depth 100mm



### A12-6251\*

Low Voltage IP65 Showerlight

\*Finish: White (WH), Nickel Matt (NM), Polished Chrome (PC), Polished Brass (PB)

- IP65 Rated
- Die cast Aluminium
- The lamp sits close to the lens enabling a wider beam angle

- Max 35w Lamp - not included
  - Needs transformer/driver and lamp
- please enquire or see transformer/driver and lamp sections

CE IP65

Diameter 82mm  
Recess Depth 105mm



### A12-6255\*

IP65 Mains Showerlight

\*Finish: White (WH), Polished Chrome (PC), Nickel Matt (NM)

- IP65 Die cast Low Voltage shower light
- Max 35w lamp - not included
- Suitable for use with low energy or LED - see lamps section
- Needs transformer/driver and lamp

- please enquire or see transformer/driver and lamp sections

CE IP65

Diameter 82mm  
Recess Depth 105mm



## Rapidly Converts to Fire-Rated



### A12-6256\*

IP65 LV/Mains Showerlight

\*Finish: White (WH), Polished Chrome (PC), Nickel Matt (NM)

- IP65 LV/Mains shower light
- Converts to Fire rated using A20-1570 105 minute rated fire can
- Needs transformer/driver and lamp

- please enquire or see transformer/driver and lamp sections

CE IP65

Diameter 82mm  
Recess Depth 50mm



Fire Can





### A12-6290

LV IP44 Round Glass Showerlight

- IP44 rated
- Max 35w lamp
- Needs transformer/driver and lamp

- please enquire or see transformer/driver and lamp sections

CE IP44 ZONE 2

Diameter 120mm  
Recess Depth 165mm



### A12-6291

LV IP44 Square Glass Showerlight

- IP44 rated
- Max 35w lamp
- Needs transformer/driver and lamp

- please enquire or see transformer/driver and lamp sections

CE IP44 ZONE 2

Size 100x100mm  
Recess Depth 165mm



### A12-6263

LV IP65 Round Mirror Glass Showerlight Fire-Rated

- Cut out - 65mm

### A12-6283

LV IP65 Round Mirror Glass Showerlight

- Cut out - 70mm

- LV versions
- Needs transformer/driver and lamp

- please enquire or see transformer/driver and lamp sections

IP65 ZONE 1

Diameter 105mm  
Recess Depth 110mm

### A12-6279

Mains IP65 Round Mirror Glass Showerlight Energy Saving

- Cut out - 70mm

### A12-6281

Mains IP65 Round Mirror Glass Showerlight

- Cut out - 70mm



### A12-6265

LV IP65 Square Mirror Glass Showerlight Fire-Rated

- Cut out - 65mm

### A12-6284

LV IP65 Square Mirror Glass Showerlight

- Cut out - 70mm

- LV versions
- Needs transformer/driver and lamp

- please enquire or see transformer/driver and lamp sections

IP65 ZONE 1

Size 86x86mm  
Recess Depth 130mm

### A12-6280

Mains IP65 Square Mirror Glass Showerlight Energy Saving

- Cut out - 70mm

### A12-6282

Mains IP65 Square Mirror Glass Showerlight

- Cut out - 70mm



## A12-9500PC

IP68 Sauna and Jacuzzi Downlight

- IP68 Rated
- Suitable for use in steam rooms
- Full fixing kit
- Needs transformer R20-1600 (see page 38)
- Can be converted to LED - [please enquire](#)

CE IP68 ZONE 0



Fixing Kit

Cut Out



65mm

Diameter 125mm  
Recess Depth 95 mm

## Easy-Fit Fibre Optic Spa/Jacuzzi Kits



### K76-1125\*

6 Light Fibre Optic Spa Kit

\*Wheel colours: White/Blue (W/B), Coloured (COL)

- Suitable for use in baths spas and jacuzzis
- Separate power feed to colourwheel to allow for continuous colour change or static colour
- Stainless steel heads
- Tail lengths 3 to 4 mtr

ZONE 0

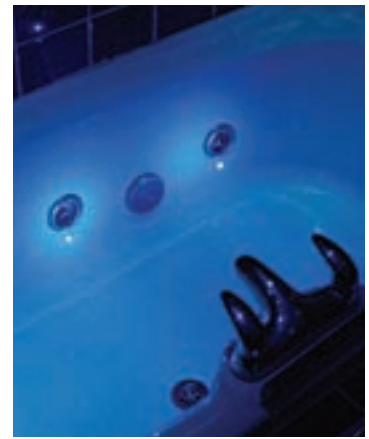

Cut Out



16mm

## Easy-Fit Fibre Optic Kits

### K76-1120\*

112 Light Heads

### K76-1121\*

224 Light Heads



\*Wheel colours: White/Blue (W/B), Coloured (COL)

- Suitable for use in steam rooms,
- White and Blue or colour wheel available

Cut Out



3mm

ZONE 1





### **A20-1580**

150 x 150 x 105mm Fire Hood

### **A20-1581**

151 x 150 x 150mm Fire Hood



### **A20-1590**

Galvanised Steel Downlight Insulation Guard

■ L340 x W340 x D150mm

### **A20-1591**

Galvanised Steel Downlight Insulation Guard

■ L220 x W220 x D140mm

- Suitable for installation in insulated loft/roof voids to protect downlights from being covered by insulation material
- Suitable for installation between all common joist spacings, Designed to meet compliance of Building Regs Part L
- NHBC & other interested parties/insurers' where the loft insulation is to be laid unbroken over the whole ceiling area to avoid thermal bridging - i.e. loss of heat through spaces normally required to be cut in the insulation for the fitment of luminaires
- Unique self supporting fixing method (no tools or screws required)
- Suitable for use in plasterboard or suspended or concrete ceilings (9-35mm)



# WALL / CEILING LIGHTS



**D02-3070\***  
Aqua Single Wall Light  
■ D140mm



**D02-3071\***  
Aqua Twin Wall Light  
■ L280 x D140mm

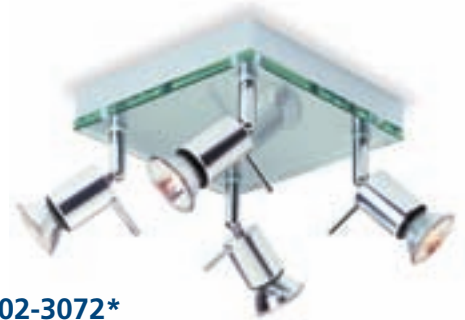

**D02-3072\***  
Aqua Quad Wall Light  
■ L190 x W190 x D140mm

- Aluminium with Clear Glass
- Switched - Single and twin versions only
- Supplied with Lamps



**NEW****D02-3073**

IP44 Ocean Single Spot

- D120mm

- Chrome with Mirror Glass
- IP44 Rated

**D02-3074**

IP44 Ocean Twin Spot

- L335 x D120mm

- Switched - Single and twin versions only
- Supplied with lamps

**D02-3075**

IP44 Ocean Quad Spot

- L230 x W230 x D120mm

ZONE  
**2****D02-3076**

Marina Single Spot

- D130mm

- Aluminium with Clear Glass
- Switched - Single and twin versions only
- Supplied with Lamps

**D02-3077**

Marina Twin Spot

- L330 x D140mm

**D02-3078**

Marina Triple Spot

- L240 x W240 x D140mm

**NEW**



### D02-3079

IP44 Atlantic Single Spot

- D145mm
- Polished Chrome
- IP44 Rated
- New 28w Energy Saving GU10 lamp supplied
- 20% Energy saving
- Switched

IP44 ENERGY SAVING ZONE 2



### D02-3080

IP44 Atlantic Twin Spot

- L340 x D145mm
- Polished Chrome
- IP44 Rated
- New 28w Energy Saving GU10 lamp supplied
- 20% Energy saving
- Switched

IP44 ENERGY SAVING ZONE 2



### D02-3081

IP44 Atlantic Triple Spot

- L230 x D145 x ø245mm
- Polished Chrome
- IP44 Rated
- 20% Energy saving
- New 28w Energy Saving GU10 lamp supplied

IP44 ENERGY SAVING ZONE 2



### D02-3082

IP44 Atlantic Quad Spot

- L735 x D145mm
- Polished Chrome
- IP44 Rated
- 20% Energy saving
- New 28w Energy Saving GU10 lamp supplied

IP44 ENERGY SAVING ZONE 2



### D02-3320\*

IP44 Tendo Wall Light

\*Finish: Brushed Steel (BS), Polished Chrome (PC)

- IP44 rated
- Frosted glass
- Pull cord
- Lamp included
- Switched

CE IP44  

Size D70 x H200mm



### D02-3321\*

IP44 Tendo Twin Wall Light

\*Finish: Brushed Steel (BS), Polished Chrome (PC)

- IP44 rated
- Frosted glass
- Pull cord
- Lamps included
- Switched

CE IP44  

Size W310 x D70mm



### D02-3322\*

IP44 Tendo 3 - Light Ceiling

\*Finish: Brushed Steel (BS), Polished Chrome (PC)

- IP44 Rated
- Frosted glass
- Lamps included

CE IP44  

Size D210 x H250mm



### D02-3323\*

IP44 Tendo 5 - Light Ceiling

\*Finish: Brushed Steel (BS), Polished Chrome (PC)

- IP44 Rated
- Frosted glass
- Lamps included

CE IP44  

Size D280 x H250mm

NEW



### D02-3096

IP44 Single Bamboo Light

- Polished Chrome and Frosted Glass
- IP44 Rated
- Supplied with lamp

IP44 ENERGY SAVING ZONE 2

Size W112 x D95 x H245mm

NEW



### D02-3097

IP44 Triple Bamboo Light

- Polished Chrome with Frosted Glass
- Energy Saving
- IP44 Rated
- Supplied with lamps

IP44 ENERGY SAVING ZONE 2

Size D230 x H380mm



### D02-3410

IP44 Mains Single Adjustable Spot

- IP44 Rated
- Flexi Arm
- Pull Cord
- Switched
- Supplied with lamp

IP44 ENERGY SAVING ZONE 2

Depth 70mm



### D02-3411

IP44 Mains Single Spot

- IP44 Rated
- Pull Cord
- Switched
- Supplied with lamp

IP44 ENERGY SAVING ZONE 2

Size D137 x ø115mm





**D02-3412**  
IP44 Mains Twin Spot

- IP44 Rated
- Pull Cord
- Switched
- Supplied with lamps

⌚ ⚡ IP44 Ⓢ ZONE 2

Size W490 x D160mm



**D02-3415**  
IP44 Mains Triple Spot

- IP44 Rated
- Supplied with lamps

⌚ ⚡ IP44 Ⓢ ZONE 2

Size H70 x ø160mm



**D02-3416**  
IP44 Mains Triple Spot

- IP44 Rated
- Supplied with lamps

⌚ ⚡ IP44 Ⓢ ZONE 2

Size H70 x H300mm



**D02-3418**  
IP44 Mains Quad Bar

- IP44 Rated
- Supplied with lamps

⌚ ⚡ IP44 Ⓢ ZONE 2

Size L870 x H70mm



**NEW**

### D02-3098

IP44 3-Light Square Tube Fitting

- Polished Chrome with Frosted Glass
- IP44 Rated
- Supplied with lamps

**IP44** **ZONE 2**

Size D210 x H450mm



**NEW**

### D02-3069

IP44 Hydra Energy Saving Wall Light

- IP44 Rated
  - Energy Saving
  - HF control gear
  - Pull cord
  - 50Lm/Wchrome base with opal glass and mirror back plate
  - Needs 1 x PL-D/E 10w lamp
- please enquire

**IP44** **ZONE 2**

Size W155 x D170 x H230mm



**NEW**

### D02-3086

IP44 Splash Single Wall Light

- Polished Chrome with Opal Glass
- IP44 Rated
- Supplied with lamp

**IP44** **ZONE 2**

Size W80 x D125 x H215mm



**NEW**

### D02-3087

IP44 Splash Tubular Wall Light

- Polished Chrome with Opal Diffuser
- Energy Saving
- IP44 Rated
- Supplied with lamp

**IP44** **ZONE 2**

Size W665 x D120 x H65mm



### D02-3088

IP44 Splash Clear Tubular Wall Light

- Polished Chrome with Clear Diffuser
- IP44 Rated
- Energy Saving
- Supplied with lamp

IP44 ENERGY SAVING

Size W640 x D190 x H45mm



### D02-3089

IP44 Splash Cylinder Wall Light

- Polished Chrome with Opal Diffuser
- IP44 Rated
- Energy Saving
- Supplied with lamp

IP44 ENERGY SAVING

Size W620 x D90 x H55mm



### D02-3090

IP44 Splash Glass Wall Light

- Polished Chrome and Frosted Glass
- IP44 Rated
- Energy Saving
- Supplied with lamp

IP44 ENERGY SAVING

Size W640 x D110 x H70mm



### D02-3091

IP44 Splash Mirror Glass Wall Light

- Mirror and Frosted Glass
- IP44 Rated
- Energy Saving
- Supplied with lamp

IP44 ENERGY SAVING

Size W640 x D115 x H70mm



### D02-3099

IP44 Prelude Ceiling and Wall Light

- IP44 Rated
- Energy Saving
- HF control gear
- 50Lm/W
- Chrome base with opal glass and mirror back plate
- Needs 1 x 18" 15w tube - please enquire



Size L494 x W70mm  
Depth 81mm



### D02-3095

IP54 Nova Square Bulkhead

- IP54 Rated
- Supplied with lamp



Size 185x185mm  
Depth 60mm



### D02-3308

Twin Glass Wall Light

- Energy Saving
- Finish: Frosted glass / Brushed Steel
- Needs 2 x PL-S 11w lamps F33-5454\*



Size W90 x D95 x H580mm



### D02-3092

IP44 370mm Striplight

### D02-3093

IP44 600mm Striplight

### D02-3094

IP44 675mm Striplight

- White with Polycarbonate Diffuser
- IP44 Rated
- Energy Saving

- Switched
- Supplied with lamps



Depth 70mm  
Height 40mm



### D02-3560\*

IP44 Small Round Bulkhead

- D180 x H60mm
- Needs a 40w lamp with a SES (E14) base

### D02-3564\*

IP44 Medium Round Bulkhead

- D310 x H75mm
- Needs a 60w lamp with a SES (E27) base

### D02-3567\*

IP44 Large Round Bulkhead

- D400 x H85mm
- Needs a 2x0w lamp with a SES (E27) base

\*Finish: Brushed Steel (BS), Polished Chrome (PC)

CE IP44 ZONE 2



### D02-3083

IP44 Profile Round Bulkhead

- ø320mm x Depth 80mm
- Needs 2 x max 40w SES lamps - [please enquire](#)

### D02-3084

IP44 Profile Round Energy Saving Bulkhead

- ø320mm x Depth 80mm
- Needs 2 x PL-S 9w lamps - [please enquire](#)
- Polished Chrome with Opal Glass
- IP44 Rated
- Energy saving

IP44 ENERGY SAVING ZONE 2



### D02-3555

28w Bulkhead HF c/w Lamp 3 Bezels

- Energy Saving
- High Frequency
- Poly carbonate construction
- Comes complete with White Chrome and Brass trims
- Supplied with lamp

CE IP44 ZONE 1

Diameter 330mm  
Width 118mm



### D02-3085

IP44 Profile Square Bulkhead

- 310mm sq x Depth 60mm
- Polished Chrome with Opal Glass
- IP44 Rated

IP44 ENERGY SAVING ZONE 2

- Energy saving
- Needs 2 x max 40w SES lamps - [please enquire](#)

# MIRROR/CABINET LIGHTS



## D06-5295

IP44 Round GX53 Make Up / Shaver Mirror

- IP44 Rated
- Needs lamp F42-1080 - [please enquire](#)

IP44

Diameter 220mm  
Fully Extended 315mm



## D06-5199

IP21 Mirror Frosted Strips with Pull Cord and Shaver Socket

- Dual voltage shaver socket
- On/Off Pull cord
- 2 x 15w T8 tubes

CE IP21

Width 390mm  
Depth 55mm  
Height 500mm



**NEW**



**D06-5200**

IP44 Mirror Frosted Strips

■ W390 x H500mm

- IP44 Rated
- Energy saving

**D06-5201**

IP44 Mirror Frosted Strips

■ W600 x H600mm

- Cool running
- Waterproof rocker



**NEW**



**D06-5202**

IP44 Mirror Frosted Squares

■ W390 x H500mm

- IP44 Rated
- Energy saving

**D06-5203**

IP44 Mirror Frosted Strips

■ W600 x H600mm

- Cool running
- Waterproof rocker

CE L F IP44 ENERGY SAVING ZONE 2

CE L F IP44 ENERGY SAVING ZONE 2



**D06-5321**

IP44 Mains Single 8w Mirror Light

Length 516mm  
Width 99mm  
Recess Depth 30mm



**D06-5322**

IP44 Mains Twin 8w Mirror Light

Length 516mm  
Width 114mm  
Recess Depth 30mm



**D06-5331**

IP44 Mains Single 13w Mirror Light

Length 718mm  
Width 99mm  
Recess Depth 30mm



**D06-5332**

IP44 Mains Twin 13w Mirror Light

Length 718mm  
Width 114mm  
Recess Depth 30mm

CE L F IP44 ENERGY SAVING ZONE 2

- Energy saving
- Can be surface mounted or recessed



**NEW**

**D06-5001**

IP44 Back Lit Mirror including Shelves, Shaver Socket and Demister

- IP44 Rated
- Sensor Switch
- 6 Integrated Shelves
- Shaver Socket
- Demister Pad
- Energy Saving

Width 600mm  
Depth 75mm  
Height 750mm

CE L F IP44 ENERGY SAVING ZONE 2

**NEW**



**D06-5002**  
IP44 Back Lit Mirror  
including 3 x Magnification,  
Pull Cord and Shaver Socket

- IP44 Rated
- Switched
- Supplied with lamp
- Magnification Mirror
- Shaver Socket
- Energy Saving

Width 700mm  
Depth 50mm  
Height 500mm

**IP44** ENERGY SAVING ZONE 2



**NEW**



**D06-5003**  
IP44 LED Mirror with Rocker Switch

- IP44 Rated
- Rocker Switch
- Energy Saving
- 96 point LED

Width 500mm  
Height 700mm

**IP44** ENERGY SAVING ZONE 2



**D06-5040**  
IP44 Mirror with IR Sensor  
and Digital Clock

Width 600mm  
Height 800mm

- IP44 Rated
- IR Sensor Switch
- Digital Clock
- Energy Saving

**IP44** ENERGY SAVING ZONE 2



**D06-5041**  
IP44 Mirror with IR Sensor  
and Digital Clock

Width 500mm  
Height 700mm

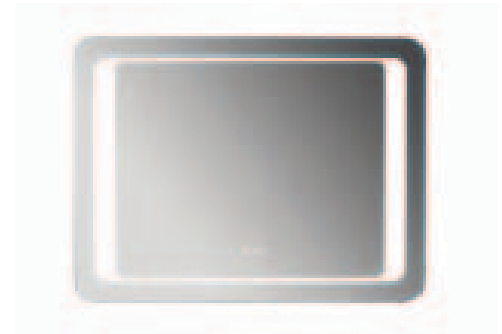

**D06-5042**  
IP44 Mirror with IR Sensor  
and Digital Clock

Width 900mm  
Height 600mm



**NEW**





### D06-5044

IP44 LED Round Halo Mirror with Demister

- Diameter 650mm

### D06-5045

IP44 LED Oval Halo Mirror with Demister

- Width 450 x Height 650mm

- IP44 Rated
- Demister Pad
- Frosted Acrylic Border
- Energy Saving
- Pull switch

IP44 ENERGY SAVING ZONE 2



### D06-5046

IP44 LED Rectangle Mirror with Demister

- Width 390 x Height 500mm

### D06-5047

IP44 LED Rectangle Mirror with Demister

- Width 540 x Height 690mm

- IP44 Rated
- Demister Pad
- Frosted Acrylic Border
- Energy Saving
- Pull switch

IP44 ENERGY SAVING ZONE 2



### D06-5026

IP21 Compact Cabinet with Shaver Socket

- Compact Cabinet
- 3 shelves
- Pull switch
- Shaver socket

CE IP21 ENERGY SAVING ZONE 2

Width 450mm  
Depth 115mm  
Height 550mm



### D06-5029

IP44 Mirror Cabinet with Rocker Switch

- Energy saving
- Dual voltage shaver socket
- Height adjustable glass shelves
- Pull switch

CE IP44 ENERGY SAVING ZONE 2

Width 600mm  
Depth 120mm  
Height 650mm



**N28-0295**  
Shaver Socket Dual Voltage - White

**L02-0247**  
2 Gang 47mm Back box  
■ Dual voltage 115/240v



**N14-0195**  
1 Gang Dual Voltage Shaver Socket  
- Polished Chrome

**L02-0147**  
1 Gang 47mm Back box  
■ Dual voltage 115/240v  
■ Single plate size



**N14-0295\***  
Polished Chrome  
Shaver Socket

**N14-0297**  
Polished Chrome Shaver Socket - White Inserts

**N12-0295\***  
Satin Stainless Steel Shaver Socket

**L02-0247**  
2 Gang 47mm Back box

\*Colours: Black inserts (BK), White inserts (WH)  
■ Dual voltage 115/240v



**N20-0295\***  
Polished Chrome Flat Plate Shaver Socket

**N16-0295\***  
Satin Stainless Steel Flat Plate Shaver Socket

**L02-0247**  
2 Gang 47mm Back box

\*Colours: Black inserts (BK), White inserts (WH)  
■ Dual voltage 115/240v





### D04-4500

Dual Voltage Shaver Light

- Pull cord
- 110/240v Shaver socket
- Striplight 60w 284mm included



Length 493mm  
Width 59mm  
Height 70mm



### IP20 Dual Voltage

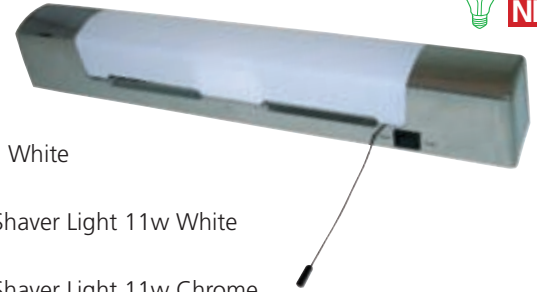

### D04-4502

Shaver Light 60 White

### D04-4506

Energy Saving Shaver Light 11w White

### D04-4507

Energy Saving Shaver Light 11w Chrome

- Pull cord
- 110/240v Shaver socket
- Lamp included



Length 440mm  
Width 71mm  
Height 70mm



### D04-4501

Dual Voltage Energy Saving 11w Shaver Light -White

- Dual Voltage
- Pull cord
- Prismatic diffuser
- Made to BS EN60598
- Supplied with lamp



Length 490mm  
Depth 70mm  
Height 60mm



### D04-4504

Dual Voltage 60w Shaver Light - 490mm Length

- Dual Voltage
- Pull cord
- Polished Chrome with Prismatic diffuser



Depth 70mm  
Height 60mm

### D04-4505

Dual Voltage 11w Energy Saving Shaver Light - 495mm Length

- Made to BS EN60598
- Supplied with lamp

### IP44 Dual Voltage



### D04-4529

Energy Saving Shaver Light

- IP44 Rated
- Energy Saving
- Pull cord
- Dual Voltage shaver socket
- Supplied with 2x9w energy saving lamps



Width 580mm  
Depth 75mm  
Height 90mm

### IP44 Dual Voltage



### D04-4530

Shaver Light

- IP44 Rated
- Chrome finish
- Pull cord
- Dual voltage
- Part 'L' compliant
- Lamp included



Length 515mm  
Depth 90mm  
Height 90mm

## 100mm 4" Axial Fans



**S02-4100**  
Standard

**S02-4110**  
Timer Fan

**S02-4120**  
Low Voltage Selv Fan

**S02-4130**  
P.I.R Fan

---

## 100mm (4") Super Low Profile Fans



**S02-4171**  
Standard

**S02-4172**  
Timer

**S02-4173**  
Humidstat and Timer

**S02-4175**  
Low Voltage Standard

**S02-4176**  
Low Voltage Timer

**S02-4177**  
Low Voltage Humidstat and Timer

VENTILATION

## 100mm (4") Spotvent Kits



(S14-4216 shown)

### S14-4206

Standard - White and Chrome Grills

### S14-4216

Timer - White and Chrome Grills

### S14-4208

Centrifugal Standard

### S14-4218

Centrifugal Timer

### S14-4209

Professional Standard

### S14-4219

Professional Timer

## Wall Fixing Kits



### S16-4001

100mm (4") Kit

## 100mm (4") inline Fan Kits



(Professional shown)

### S02-4202

Standard

### S02-4212

Timer

### S02-4203

Professional Standard

### S02-4213

Professional Timer

### S34-3510\*

100mm Indoor Round Grille

\*Finish: White (WH), P.Chrome (PC)

## 100mm (4") Low Voltage LED



### S02-4190

Standard LED

### S02-4191

Timer LED

■ Comes complete with low voltage transformer

# TRANSFORMERS/ WIRING ACCESSORIES



## R20-1600

10-60Va Wired Transformer

- Fully Dimmable



## R20-1600B

Budget 20-60Va Wired Transformer

- Fully Dimmable



## R20-1668

20-60Va IP68 Transformer

- Fully Dimmable



### R20-1610

20-60Va With Port Amp Connector Transformer

- Fully Dimmable



### K11-9016

16w LED Power Converter



### K11-9017

9w LED CC Driver

- 350mA constant current output
- Suitable for 1-9w LEDs
- Overload, short-circuit & thermal protection
- 1.0KV Surge protection
- Non dimmable
- Series wiring only
- L144 x W38 x D24mm



### K11-9068

IP68 16w LED Power Converter



### K11-8263

6w Led Power Converter

### K11-8269

15w LED Power Converter

### K11-8270

30w LED Power Converter

- Comes with 6-Port Amp Connector



### K11-8264

6w LED Power Converter

### K11-8265

15w LED Power Converter

### K11-8266

30w LED Power Converter

- Comes with Mic Connector



### K11-1307

12V 48w RGB LED Driver



### K11-9209

12V DC 100w LED Power Converter

- L159 x W97 x D38mm



### K30-2011

RGB 12/24V Remote Control Kit

- L130 (Including Fixing Holes) x W64 x H24mm

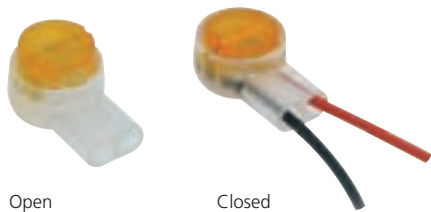

**L08-4167**  
IP68 Mini Connector



**L08-4170**  
IP68 Waterproof Cable Connector

**IP68**



**N28-0188**  
IR Sensor With Remote Sensor

- 2 Mtr Sensor Cable
- Input 100-240V
- Max load power 250VA



Length  
Width  
Height



13mm  
76mm  
36mm  
19mm



**N28-0189**  
Mini Motion Detector

- P.I.R Technology
- Input 220-240v
- Output 600w max
- Delay time 45sec
- Switches on the Mains side

Length  
Width  
Height

76mm  
35mm  
16mm

(N14-0162 shown)



**N28-0162**  
6 Amp Pull Switch - White

**N14-0162**  
6 Amp Pull Switch - Chrome

**N28-0145**  
45 Amp Pull Switch - White

**N14-0145**  
45 Amp Pull Switch - Chrome



**N28-0190**  
LED IR Motion Sensor Switch



12mm



**L08-4169**  
IP68 Series (Luxeon) Junction Box



**L08-4618**  
IP68 Junction Box for LV

- 1 input 3 outputs
- 24V 150W max

CE





### N28-5004

#### Taptile Starter Kit

- Full Starter kit with includes:  
1 x N28-5000 6 way touch sensor  
2 x N28-5002 Inline dimmer modules 300w rated  
1 x N28-5003 on/off module 1000w rated
- The power needed is supplied by a plug in transformer with a 3mtr power lead to the touch sensor - the rest is wireless saving time and money

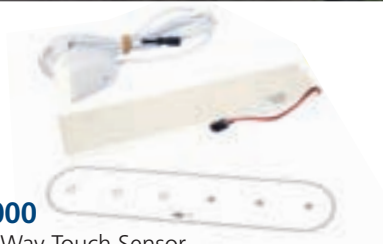

### N28-5000

#### Taptile 6 Way Touch Sensor

- 6 Button Waterproof controller - IP68 rated
- Simply sticks to the back of the tile wood ceramic or drywall surface
- Ultra slim - only 8mm
- Can be fitted in wet areas such as by the sink shower or bath
- Up to 6 touch sensors can be used in one room
- A stick on transferable decal is supplied
- Alternatively switches can be located by using matching mosaics, shells or pebbles
- The power needed is supplied by a plug in transformer with a 3mtr power lead - the rest is wireless



Depth 8mm



### N28-5005

#### Taptile Ceramic Tile Etching Kit

- Enables you to Etch the tile (where suitable) and fill with grout to locate switches



### N28-5001

#### Taptile Pull Cord Dimmer 210w SPST

- 210w rated wireless module
- Converts your pull chord into a wireless touch controlled dimmer

### N28-5002

#### Taptile Inline Dimmer 300w DPST

- 300w rating wireless module
- Up to six wireless modules can be used per room
- All six modules can be programmed to one touch sensor enabling up to 36 x 50w lights to be controlled and dimmed at once

### N28-5003

#### Taptile Inline Switch 1000w DSPT

- 1000w rated wireless module
- Ideal for switching non-dimmable items such as fans, mirrors, demister pads, LEDs etc



LAMPS



### F50-5008

GU10 9w Warm White

### F50-5012

GU10 11w Warm White

- Energy Saving
- Long life



### F50-6009\*

SGU10 63mm 9w

### F50-6011\*

SGU10 63mm 11w

\*Colours: Warm White (WW), Cool White (CW)

- 40Lumens Per Watt
- Part L1 Compliant



### K14-7100\*

G4 LED Capsule

\*Colours: Cool White (CW), Warm White (WW), Blue (BL)

- Energy saving
- Cool running temperature



### K14-8208\*

MR8 (25mm) L.V. LEDs

\*Colours: Blue (BL), Green (GR), Orange (OR), Red (RD), White (WH)

- Energy saving
- Cool running temperature



### K14-8516\*

MR16 (50mm) L.V. LEDs

\*Colours: Blue (BL), Green (GR), Orange (OR), Red (RD), White (WH), Warm White (WW)

- Energy saving
- Cool running temperature



### K14-8533\*

MR16 5w Hi-Power LED

\*Colours: Cool White (CW), Daylight (D), Warm White (WW)

- Instant start
- No UV
- ROHS compliance
- Cool White - 64Lm/W (320Lm)
- Daylight - 66Lm/W (330Lm)
- Warm White - 60Lm/W (300Lm)
- 36° beam angle
- Average life expectancy 30000hrs
- L52.5 x 50mm ø
- Needs LED Driver
- K11-9016 see page 39



### K14-8311\*

MR11 (35mm) L.V. LEDs

\*Colours: Blue (BL), Green (GR), Orange (OR), Red (RD), White (WH), Warm White (WW)

- Energy saving
- Cool running temperature



### K14-8517

MR16 (50mm) L.V. Colour Changing LEDs

- Energy saving
- Cool running temperature



### K14-8535\*

MR16 5w Dimmable Hi-Power LED & Driver

\*Colours: Cool White (CW), Daylight (D), Warm White (WW)

- Dimmable
- Comes complete with dimming LED Driver
- Instant start
- No UV
- ROHS compliance
- Cool White - 64Lm/W (320Lm)
- Daylight - 66Lm/W (330Lm)
- Warm White - 60Lm/W (300Lm)
- 36° beam angle
- Average life expectancy 30000hrs
- L58 x 50mm ø



### K14-8312\*

MR11 12V 2w Hi-Power Spot

\*Colours: Daylight (D), Warm White (WW)

- Instant start
- No UV
- ROHS compliance
- Daylight - 45Lm/W (90Lm)
- Warm White - 38Lm/W (75Lm)
- 30° beam angle
- Average life expectancy 30000hrs
- L37 x 35mm ø
- Needs LED Driver
- K11-9016 see page 39



### K14-8531\*

MR16 4w Hi-Power LED

\*Colours: Cool White (CW), Daylight (D), Warm White (WW)

- Instant start
- Improved Lumen output (180Lm)
- No UV
- ROHS compliance
- Cool White - 47Lm/W (190Lm)
- Daylight - 52Lm/W (210Lm)
- Warm White - 45Lm/W
- 36° beam angle
- Average life expectancy 30000hrs
- Needs LED Driver
- K11-9016 see page 39



### K14-8537\*

MR16 7w Hi-Power LED

\*Colours: Cool White (CW), Daylight (D), Warm White (WW)

- Instant start
- No UV
- ROHS compliance
- Cool White - 53Lm/W (370Lm)
- Daylight - 60Lm/W (420Lm)
- Warm White - 51Lm/W (360Lm)
- 36° beam angle
- Average life expectancy 30000hrs
- L66 x 50mm ø
- Needs LED Driver
- K11-9016 see page 39



### K14-8510\*

GU10 240V LEDs

\*Colours: Blue (BL), Green (GR), Orange (OR), Red (RD), White (WH), Warm White (WW), Yellow (YL)

- Energy saving
- Cool running temperature



### K14-8532\*

GU10 5w Hi-Powered LED

\*Colours: Cool White (CW), Daylight (D), Warm White (WW)

- Instant start
- No UV
- ROHS compliance
- Cool White - 64Lm/W (320Lm)
- Daylight - 66Lm/W (330Lm)
- Warm White - 60Lm/W (300Lm)
- 36° beam angle
- Average life expectancy 30000hrs
- L57.5 x 50mm ø



### K14-8538\*

GU10 7w Dimmable Hi-Powered LED

\*Colours: Cool White (CW), Daylight (D), Warm White (WW)

- Dimmable
- Instant start
- No UV
- ROHS compliance
- Cool White - 53Lm/W (370Lm)
- Daylight - 60Lm/W (420Lm)
- Warm White - 51Lm/W (360Lm)
- 36° beam angle
- Average life expectancy 30000hrs
- L71 x 50mm ø



### K14-8511

GU10 Mains Colour Changing



### K14-8534\*

GU10 5w Dimmable Hi-Powered LED

\*Colours: Cool White (CW), Daylight (D), Warm White (WW)

- Dimmable
- Instant start
- No UV
- ROHS compliance
- Cool White - 64Lm/W (320Lm)
- Daylight - 66Lm/W (330Lm)
- Warm White - 60Lm/W (300Lm)
- 36° beam angle
- Average life expectancy 30000hrs
- L63 x 50mm ø



K02-2404



### K14-8530\*

GU10 4w Hi-Powered LED

\*Colours: Cool White (CW), Daylight (D), Warm White (WW)

- Instant start
- Improved Lumen output
- No UV
- ROHS compliance
- Cool White - 47Lm/W (190Lm)
- Daylight - 52Lm/W (210Lm)
- Warm White - 45Lm/W (180Lm)
- 36° beam angle
- Average life expectancy 30000hrs
- L55 x 50mm ø



### K14-8536\*

GU10 7w Hi-Powered LED

\*Colours: Cool White (CW), Daylight (D), Warm White (WW)

- Instant start
- No UV
- ROHS compliance
- Cool White - 53Lm/W (370Lm)
- Daylight - 60Lm/W (420Lm)
- Warm White - 51Lm/W (360Lm)
- 36° beam angle
- Average life expectancy 30000hrs
- L71 x 50mm ø

### K02-2402

Tri - Star Master

### K02-2404

Tri - Star Remote

### K02-2403

Tri - Star Slave

### K02-2405

Tri - Star GU10 RGB

- GU10 Size
- 5W CREE Lamp
- NO UV OR IR

- 35000hrs plus
- Mains voltage





### F30-2215

Energy Saving Striplight 221mm 5w  
Opal 6000Hr 2700K

### F30-2847

Energy Saving Striplight 284mm 7w  
Opal 6000Hr 2700K

- Energy saving
- Long life
- Low heat
- 30mm ø



### K14-1221

LED Striplight 221mm 2w Warm White

### K14-1222

LED Striplight 221mm 2w Cool White

### K14-1284

LED Striplight 284mm 3w Warm White

### K14-1285

LED Striplight 284mm 3w Cool White

- Energy saving
- Long life
- Low heat
- 30mm ø



### G04-2008

MR8 25mm 12V 20w 36° GU4

### G04-3508

MR8 25mm 12V 35w 36° GU4

- Energy saving
- Cool running temperature
- L66 x 50mm ø



### G04-2011

MR11 35mm M221 12V 20w 38° Closed

### G04-3511

MR11 35mm M223 12V 35w 38° Closed



### G04-2016

MR16 50mm M269 12V 20w 38° 5,000Hr Branded

### G04-2116

MR16 50mm M269 12V 20w 38° Unbranded

### G04-3516

MR16 50mm M281 12V 35w 38° 5,000Hr Branded

### G04-3616

MR16 50mm M281 12V 35w 38° Unbranded

### G04-5016

MR16 50mm M258 12V 50w 38° 5,000Hr Branded

### G04-5116

MR16 50mm M258 12V 50w 38° Unbranded



### G06-2010

GU10 20w 240V Branded

### G06-3510

GU10 35w 240V Branded

### G06-3610

GU10 20w 240V Unbranded

### G06-5010

GU10 50w 240V Branded

### G06-5020

GU10 50w 240V 4,000 Hr Branded

### G06-5110

GU10 50w 240V Unbranded

## IP RATINGS EXPLAINED

### 'IP' (INGRESS PROTECTION) RATING

**FIRST DIGIT:** Protection against ingress of foreign bodies e.g. tools, dust, fingers, etc.

**SECOND DIGIT:** Protection against ingress of liquids i.e. IP44 is protection against solid objects greater than 1mm and water sprayed from all directions.

#### FOREIGN BODIES FIRST DIGIT

- 0 No protection
- 1 Protected against solid objects greater than 50mm (e.g. accidental touch by hands)
- 2 Protected against solid objects up to 12mm (e.g. fingers)
- 3 Protected against solid objects greater than 2.5mm (e.g. tools and wires)
- 4 Protected against solid objects greater than 1mm (e.g. small tools and wires)
- 5 Protected against dust, limited ingress (e.g. no harmful deposit)
- 6 Totally protected against dust

#### LIQUIDS SECOND DIGIT

- 0 No protection
- 1 Protection against vertically falling drops of water (e.g. condensation)
- 2 Protection against direct sprays of water up to 15 degrees from vertical
- 3 Protection against direct sprays of water up to 60 degrees from vertical
- 4 Protection against water sprayed from all directions – limited ingress permitted
- 5 Protected against low pressure jets of water from all directions – limited ingress permitted
- 6 Protected against high pressure jets of water (use on ship deck) – limited ingress permitted
- 7 Protected against the effects of immersion between 15cm and 1m
- 8 Protected against long periods of immersion under pressure

## IP ZONES

**ZONE  
0**

Inside the bath or shower. Any fittings used here must be SELV (max. 12v). A minimum rating of IPx7 is required here.

**ZONE  
1**

Above the bath to a height of 2.25m. A minimum rating or IPx4 is required here.

**ZONE  
2**



























The area stretching to 0.6m outside the bath and above the bath if over 2.25m. An IP rating of at least IPx4 is required here.

This information is intended as a guide and contains several generalisations for illustrative purposes. For more technical information refer to an electrician and specific product data.



All data is accurate at time of going to print and the company reserves the right to alter technical specifications at any time and without prior notification. Sizes are a guide only and all colours are subject to levels of accuracy determined by limitations of the printing process.

## GLOSSARY OF ICONS

1		CE mark which indicates the compliance with the low voltage and electromagnet compatibility	18		Thermal cut out temperature.	35		Lamp included / needed
2		Product certified to British Standards.	19		Product certified through the respective certifying body.	36		LED technology
3		Product certified through the respective certifying body.	20	<b>IP65</b>	Rating for protection against solid and liquid ingress.	37		T5 LAMPS INCLUDED 4000°K
4		Product certified through the respective certifying body.	21	<b>IP44</b>	Rating for protection against solid and liquid ingress.	38	<b>IP20</b>	
5		Product certified through the respective certifying body.	22	<b>IP68</b>	Rating for protection against solid and liquid ingress.	39		LAMP INCLUDED 50W MAX
6		Product certified through the respective certifying body.	23	<b>IP21</b>	Rating for protection against solid and liquid ingress.	40	<b>ENERGY SAVING</b>	
7		Product certified through the respective certifying body.	24	<b>IP54</b>	Rating for protection against solid and liquid ingress.	41		GU4 CAP INCLUDED 20W MAX
8		Product certified through the respective certifying body.	25	<b>IP66</b>	Rating for protection against solid and liquid ingress.	42		50W MAX
9		Product certified through the respective certifying body.	26	<b>IP67</b>	Rating for protection against solid and liquid ingress.	43		Indoor lighting only
10		Product certified through the respective certifying body.	27	<b>EQUIV. SELV</b>	Safe, extra low voltage.	44		Outdoor lighting only
11		Class 1 lighting: includes earth protection as a complementary security measure against electrical shocks.	28		Product certified through the respective certifying body.			
12		Class 2 lighting: Includes a reinforced or double insulation as a protection against electrical shocks.	29		Product certified through the respective certifying body.			
13		Class 3 lighting: The protection against electrical shocks comes from the supply of very low security tension.	30		Product certified through the respective certifying body.			
14		Minimum distance in meters between the lamp and the surfaces or objects directly lighted.	31		Product certified through the respective certifying body.			
15		Suitable for installation on normally combustible surfaces.	32		Product certified through the respective certifying body.			
16		Suitable for use in furniture.	33		Product certified through the respective certifying body.			
17		Diameter of cut for the embedment in millimetres.	34		Mains voltage			

THE LIGHTWORKS  
BRUNEL HOUSE  
BRUNEL CLOSE  
HARWORTH  
DONCASTER  
SOUTH YORKSHIRE  
DN11 8QA  
T 01302 741941  
F 01302 741942  
E sales@the-lightworks.com  
www.the-lightworks.com

